

# E-Brake 300T Ultra Dual Drive

The first electronic press brake for heavy-duty work



300T Ultra Dual Drive



**SAFAN  
DARLEY**

The E-evolution in sheet metal working

The E-evolution in sheet metal working increases your competitive strength as a manufacturer

# The E-evolution in sheet metal working

As the inventor of the electronic press brake, SafanDarley set in motion a worldwide Evolution in sheet metal working. Even now, SafanDarley continues to work on innovative ways to raise your efficiency levels.



These innovations are the continuation of our previous milestones, such as the first CNCK servo-hydraulic brake press in 1980, the first servo-electronic brake press SMK in 1995, the first hybrid guillotine shearing machine in 1999 and the first fully-fledged electronic brake press, the original E-Brake, in 2004. This revolutionary machine concept started a global 'E-evolution in sheet-metal working'. SafanDarley now offers a unique programme of electronic brake presses, from the E-Brake 20T Ergonomic to the E-Brake 300T Dual Drive. In the heavier segment too SafanDarley is the leader in innovation, as evidenced by the new generation SafanDarley H-Brake with its unique durable hydraulics.

All SafanDarley machines are operated by means of SafanDarley E-Control Touch Screen control, the most user-friendly Man/Machine interface available. The combined expertise of SafanDarley is particularly strong in the field of automated bending cells and client-specific production solutions, with custom-made machines if so desired. The SafanDarley E-Brake 'Dual Drive' 300T now makes the unique advantages of the E-Brake technology available in the heavy segment of pressure forces up to 330 ton. This breakthrough was possible only thanks to a new SafanDarley invention: the 'Dual Drive' with a double pulley system. Together with the newly developed bearer and the new E-Control Touch Screen control, this results in an unprecedented increase in performance in the heavy segment.



SafanDarley E-Brake 300T Ultra Dual Drive



# A head start with the SafanDarley E-standards

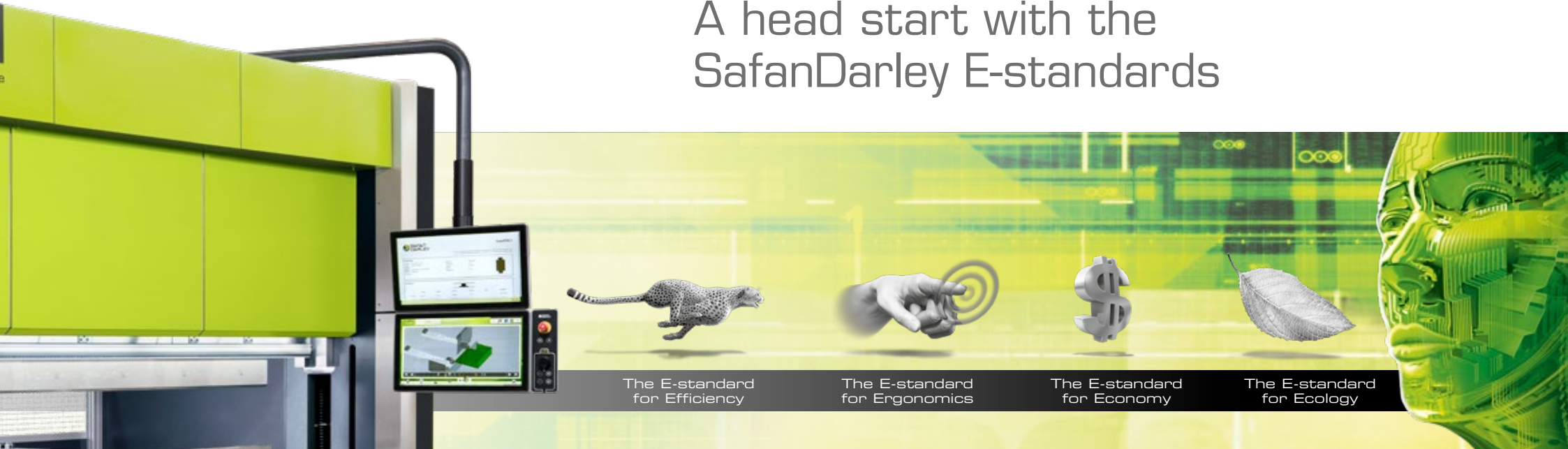

The E-standard  
for Efficiency

The E-standard  
for Ergonomics

The E-standard  
for Economy

The E-standard  
for Ecology

SafanDarley has set new standards in terms of efficiency, economy, ergonomics and ecology with the SafanDarley E-Brake machine concept. These E-standards will give you, as a sheet-metal working manufacturer, a head start over your competitors, now also with sheet bending using pressure forces up to 330 ton. What are the most important advantages for you in comparison with (traditional) hydraulic press brakes?

**The E-standard in Efficiency:** Up to 30% shorter cycle times, bending without crowning, back stop can be used across the entire working length, optimum programmability. **The E-standard in Economy:** Up to 50% energy savings, minimum maintenance costs. **The E-standard in Ergonomics:** SafanDarley E-Control touch screen controls, significant bending leeway due to slender lower beam, optimum safety. **The E-standard in Ecology:** No environmentally harmful oil, low-noise operation



The E-volution in sheet metal working

# The SafanDarley Dual Drive, a unique innovation

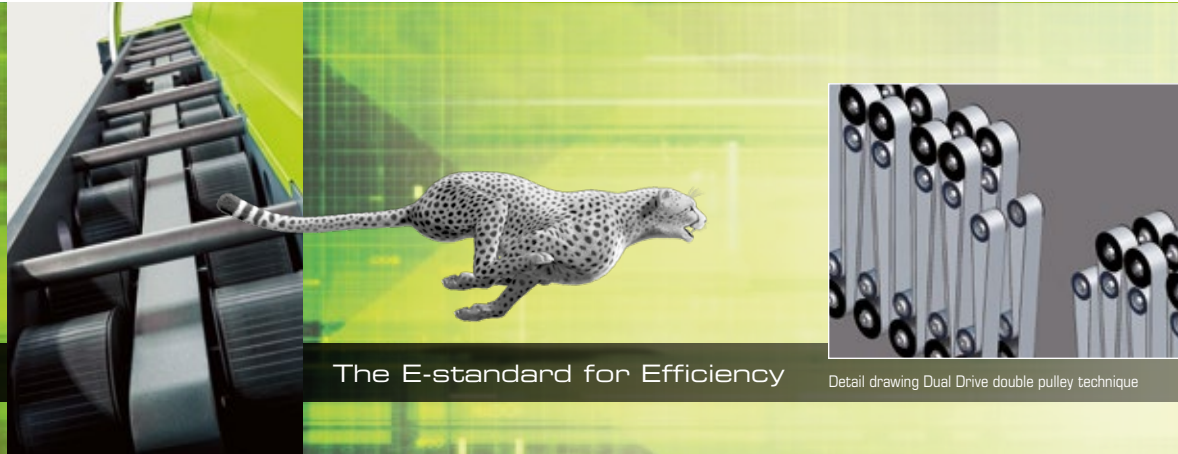

The E-standard for Efficiency

Detail drawing Dual Drive double pulley technique

Dual Drive double pulley technique

As a manufacturer of the most advanced press brakes, SafanDarley is aware of the requirements that are set in the heavy-duty market. This know-how is combined with the latest technology in the field of electronic bending in the SafanDarley E-Brake 300T Ultra Dual Drive. In order to facilitate the step towards tonnages of 330 ton (and more in the future), the SafanDarley R&D department were faced with an amazing challenge: developing a new concept drive based on the tried and tested E-Brake pulley technique. The solution was found in a double pulley system, the patented SafanDarley Dual Drive.

## 330 ton of evenly distributed pressing force

The press beam is driven by eight servo-motors on four axes using the double pulley system. In a perfect balancing act with fixed and flexible rolls, flexible belts are used to create the most perfectly even distribution of forces across the entire press beam. The polyurethane belts are 4 inch wide and reinforced with steel wires, a very reliable and abrasion resistant technology that is also used in the elevator industry. This is why SafanDarley gives a 5 year guarantee on this part of the drive (in combination with an annual service contract). Thanks to the balanced distribution of force, the deflection is still minimal, even at 330 ton pressing force. And another SafanDarley innovation is used to eliminate the very same minimum deflection!



The unique pulley drive of SafanDarley has proven itself around the world

# Perfectly compensating lower beam, just as unique



SafanDarley E-Brake  
300T Ultra Dual Drive

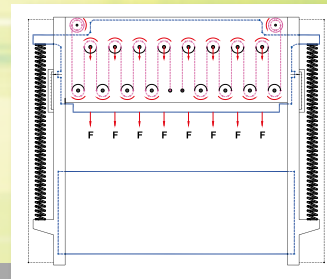

Force distribution with Dual-Drive drive

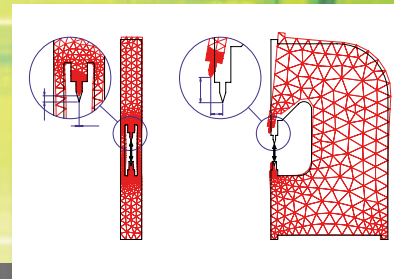

E-Brake

Conventional

The lower beam of the SafanDarley E-Brake 300T Ultra Dual Drive is a completely new development, as a second important innovation within the E-Brake concept for the heavy-duty market. The lower beam perfectly compensates the minimum deflection, eliminating the need for a crowning table, even at maximum pressing force. The machine does not have to be fitted with a sword. The lower beam is only 7 inch wide, a beam as slim as this is unprecedented in this heavy-duty machine class. The machine also has an exceptionally large 15.75 inch stroke. This means that the SafanDarley E-Brake 300T Ultra Dual Drive provides an e-normous freedom to bend for your operators.

## Reinforced O-frame for optimum stability

The machine has a very stable O-frame construction with a reinforced bridge and side frames. The bending tools remain in a straight line even under maximum bending loads. In addition to optimal stability, there is another advantage to this construction: the backgauge can be used across the entire working length of the machine.



# Switch to 330 ton of competitive power

You will have a much stronger position in the market with the new SafanDarley electronic heavy-weight. You can produce the most accurate and constant bending angle across the entire 13 ft range of the machine without the need for crowning. Faster, uses less energy, more ergonomic and durable than any other hydraulic press brake.



The E-standard for Economy

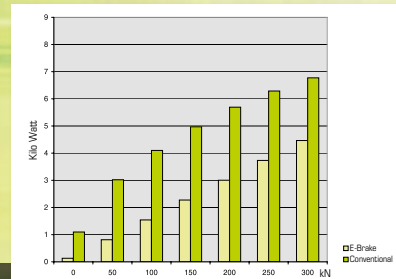

SafanDarley E-Brake energy consumption

## A step forwards in productivity

Due to the electronic drive (therefore no valves and other hydraulic delays), the switching times of the SafanDarley E-Brake Dual Drive are extremely short. This results in a cycle time that is an average of 30% faster than a conventional hydraulic press brake.

## A step forwards in safety

In terms of the safety of your operators, the SafanDarley E-Brake Dual Drive provides the ultimate solution: a safety screen that is automatically controlled from the SafanDarley E-Control controls. This also contributes to achieving the shortest possible cycle times.

## A step forwards in durability

The absence of hydraulics means that the problems associated with environmentally harmful and risky oil are a thing of the past. The servo-electronic system is therefore much more reliable than the hydraulic system due to the absence of oil, tank, pump, seals, valves and filters.

## A step forwards in energy savings

The SafanDarley E-Brake Dual Drive only uses energy when the upper beam is actually moving. This generates considerable savings that can amount to 50% in comparison with conventional hydraulic press brakes. This means that an enormous decrease in your production costs goes hand in hand with a much lower burden on the environment.

## A step forwards in working range

The backgauge can be used across the entire working length by using an O-frame machine construction.



# Heavy duty backgauge with a large range



Integrated safety light guard

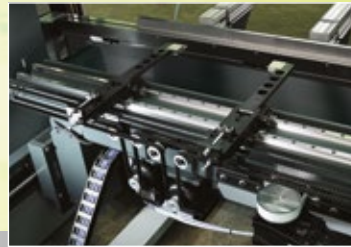

Heavy-duty backgauge



Standard backgauge stops



3D backgauge stops



The SafanDarley E-Brake 300T Ultra Dual Drive is equipped with a heavy-duty CNC-controlled backgauge system fitted with recirculating ball screws and precision linear ball-bearing guides. The basic model comes complete with CNC-controlled X axis.

The standard version of the backgauge has two hinging backgauge fingers that can be manually moved along the bending line (Z axis) as well as adjusted in height (R axis). The stop fingers are provided with interchangeable pins. In optimum use, they permit a maximum backgauge range of 43.3 inch. Optional equipment includes backgauge systems equipped with CNC-controlled R, Z1, Z2 and delta X-axis, or full 3D movement with X1, X2, Z1, Z2, R1, and R2 axes.

# SafanDarley E-Control, the new E-standard in ergonomics

Since the introduction in 1995, the SafanDarley E-Controls have been the international standard for ease of operation. The SafanDarley touch screen concept is therefore the most functional and intuitive Man-Machine interface in the sheet-metal working industry. SafanDarley have once again shifted the standards with the SafanDarley E-Control as the latest generation touch screen controls.

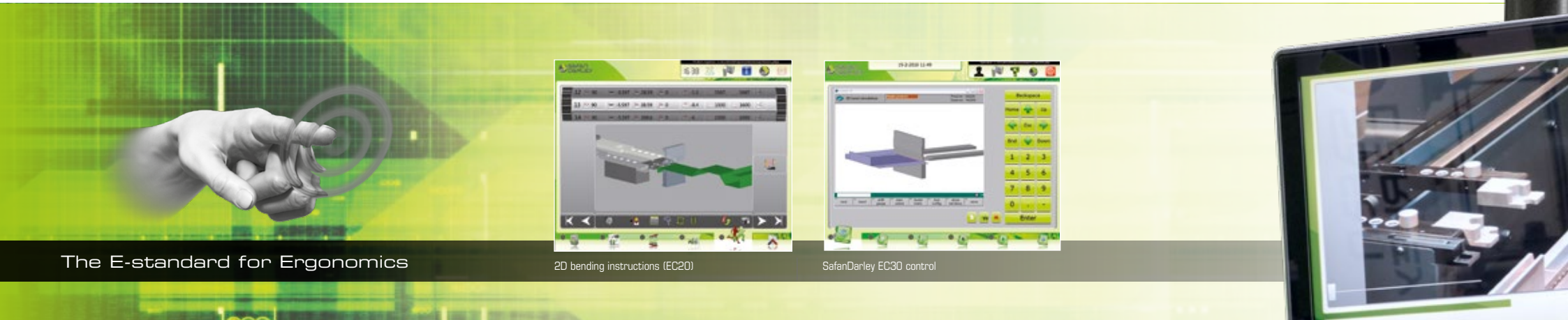

The E-standard for Ergonomics



2D bending instructions (EC20)



SafanDarley EC30 control

## Complete Touch Screen convenience

The SafanDarley E-Control is fully touch screen, whereby the only buttons visible on the 21" screen are those that are needed during operation. The controls simply run on a PC under Microsoft Windows®, the software was developed based on Microsoft.net Framework. The unit is fitted with a 100 MB Ethernet UTP network connection as standard. The instructions are transmitted to a central processor from the SafanDarley E-Control controls, which in turn regulates the various axis via a so-called CAN-BUS (Control Area Network). The system

can be programmed quickly and accurately thanks to a 'self-teaching' database with data on materials, tools and previous, already corrected bending. The SafanDarley E-Control can be coupled to the majority of off-line programming systems. The standard E-Control 20 facilitates both numeric and 2D graphical programming. It is possible to draw a complete product by means of touch screen and to then automatically generate a bending program. The developed length is also calculated. The optional E-Control 30 can be used to generate 3D drawings.

## Web-based communication and support

The controls are set-up for web-based communication such as online diagnoses and loading software updates via the web. Machines can also be coupled to each other in a group and tooling databases can be shared. By monitoring and analysing your operating data online, SafanDarley will be in a position to optimise your production process from a distance in the near future.





# Summary of SafanDarley press brake controls EC20 - EC30



SafanDarley Dual screen



2D programming (EC20)

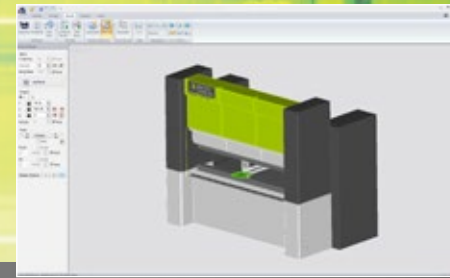

Off-line 3D programming (AutoPOL)



Control type	Possibilities	Off-line connections to
<b>EC20</b>	Numerical product data entry by means of touch screen - extensive tools library - numeric entry of bending parameters - usage of the actual database - 2D programming of products automatic bending sequence calculation with EC Profiler - 2D and 3D graphic display of products programmed offline for Autopol and Radan	- SafanDarley EC software - Delem Profile on Windows - Delem V-Bend - Autopol - Radan
<b>EC30</b>	As EC20, but with graphical 2D and 3D programming and representation of the bending sequence	- SafanDarley EC software - Delem Profile on Windows - Delem V-Bend - Autopol - Radan

# Options for optimum ease of operation

Fast, simple and reliable angle measurement can be essential for your bending process. SafanDarley has made E-evolution advancements in this area too. Two SafanDarley E-Bend systems, electronically linked to the SafanDarley Touch Screen controls, increase your efficiency through exact sheet thickness or angle measurement.



The E-standard for Efficiency



SafanDarley E-Bend S



## SafanDarley E-Bend S

The SafanDarley E-Bend S sheet thickness measurement system is mounted next to the backgauge finger. The system measures the sheet thickness to an accuracy of  $\pm 0.0004$  inch. It can be precisely programmed when measurement should take place. Measurement takes just tenths of a second and the data in the control system is immediately adjusted. The control system database maintains all records of measurement and is set out graphically.

## SafanDarley E-Bend L Blue

The system consists of two laser sensors, one each side of the table that are CNC controlled through the control system. The system continuously monitors and corrects the position of the Y axis on the basis of the actual angle of the product, thereby guaranteeing that the end product has the highest degree of angle precision. Where necessary, the system automatically corrects the crowning and takes the spring-back into account. To that end, the new generation

of E-Bend L Blue is equipped with blue laser sensors. This is because the blue light spectrum is much easier to distinguish from "natural" light, so reflections and sunlight can no longer interfere with the measurement. In addition, combined with the new control platform on the E-Control, the new sensor can perform far more measurements per second. This makes the system more accurate, as it is able to respond to measurements sooner. The E-Bend L Blue (patent pending) can be used in three ways

- Angle measurement with measurement of the spring-back
- Angle measurement with a database
- Angle measurement with learned bending

In the angle measurement with spring-back, the E-Bend L Blue measures at one or three positions during the bending process, corrects the crowning and (Y1 & Y2) positions, and measures the spring-back. These details are then stored in the database. This database is used in angle measurement with a database, making the bending process faster and thus preventing production time from being wasted.



SafanDarley E-Bend L Blue

# The most versatile bending aids

The new SafanDarley bending aids provide you with unprecedented flexibility and versatility. For example, both height and V-size are variable and easy to adjust on the bending aid. As a result, the new SafanDarley E-Mate bending aids can be used in conjunction with practically all dies instead of being compatible with only one type of die.



SafanDarley E-Mate Plus bending aid



SafanDarley E-Mate 2000

## E-Mate plus

- Electrically powered bending aid controlled by an AC Servo motor
- The E-Mate plus has a bending movement of 168,6 lbs
- Movable on linear rails and can be removed using a pallet truck
- Bending aid movements synchronous with that of the pressing beam
- Manual V-groove setting ranging from  $V = 0,24''$  to  $V = 1,97''$
- Programmable bending speed and retraction speed
- Support arm 47,24" in length, extendable up to 70,87"

## E-mate 2000

- Electrically powered bending aid controlled by an AC Servo motor
- The E-Mate 2000 has a bending movement of 1475"/lbs
- Movable on linear rails and can be removed using a pallet truck
- Bending aid movements synchronous with that of the pressing beam
- Manual V-groove setting ranging from  $V = 0.24''$  to  $V = 5.91''$
- Programmable bending speed and retraction speed
- Table with steel rollers, 23.62" x 39.37", equipped with extended support arm of up to 62.99"



# Moveable and adjustable support arms

SafanDarley has developed a range of support arms of modular construction for both light and heavy-duty sheet-metal work. This makes it possible to rapidly set up the correct solution for each application. An optimum combination of ergonomics and efficiency.



The E-standard for Ecology



Movable support arms

All support arms can be used in combination with the light guard. The support arms are as standard equipped with brushes. You can choose from the following possibilities:

- Support arms fixed to the machine
- Support arms movable across the front side of the machine
- Support arms movable across the front side of the machine and height adjustable with a handwheel
- Support arms movable across the front side of the machine and pneumatically adjustable in height (programmable on the control)

Optionally all support arms can be equipped with adjustable front stops.



Movable support arms adjustable in height



# Turn-key delivery of automated bending solutions

In 1988, SafanDarley had already installed the first robotic press brake in Europe. SafanDarley is now an experienced specialist in the field of automated bending cells including the standard SafanDarley R-Brake. The SafanDarley integral solutions for your production process go much further than stand-alone solutions.

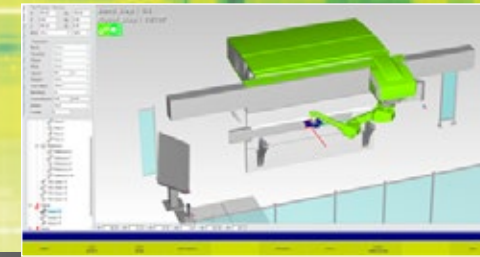

Off-line programming

The integral automation is not restricted to the bending cell alone, this also applies to other parts of the process such as punching and spot-welding, and the entire routing of sheet material around the bending cell.

## Flexible solutions and off-line software

You retain your flexibility with SafanDarley in terms of new products or changes in your production process. You are also flexible in relation to coupling with external systems and choosing your robot. The SafanDarley

E-Brake is perfectly suited to operate as a mid-point for every automated bending cell. The SafanDarley controls run under the Windows® platform, adding a whole range of options for links, networks, software packages and resolving downtime of the unmanned production process over the Internet. SafanDarley can supply complete, fully tested programs for both new and existing robotic cells. You have a choice between off-line or parametric programming. Naturally, you can contract out all programming to SafanDarley.

The SafanDarley RoboBend off-line programming is a guarantee for maximum efficiency of your bending cell. All movements can be programmed and simulated in advance.

## From advice & consultancy to manufacturing

SafanDarley makes automation of sheet-metal working easier than you think. This starts with the convenience of a single contact person for the entire project. Our consultants clearly present you with the entire range of options, enabling you to make the best possible choice for your production

process. SafanDarley develops and realises turnkey solutions for bending and cutting systems with guaranteed cycle times. This fixes the costs per product. The return time of your investment can be properly determined based on those set costs. With the help of a simulation model, you will get a reliable indication beforehand of your expected Return On Investment.

# SafanDarley E-Brake 300T Ultra Dual Drive



## Standard features

- SafanDarley EC20 Touch Screen CNC press brake controls
- CNC-controlled R- axis
- CNC-controlled Y1-Y2 axis (top beam adjustable inclined +/- 0.1 inch)
- CNC-controlled backgauge (X-axis) with a wide range
- Manual adjustment of 2 backgauge fingers across a linear parallel guide
- NSCL II MC Premium top tool mechanical clamping system and NSCR II MC Premium crowning
- Built in size of 27.16 inch (Q-dimension)
- 2 support arms (11.81 inch in length)
- 1 Hold to Run operating console
- Programmable and integrated safety light guard
- Safety in compliance with CE

Tabel Tool adapters SafanDarley E-Brake  
300T Ultra Dual Drive

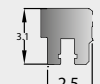

NSCL II  
MC Premium

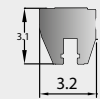

NSCL II  
HC Premium

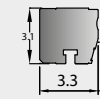

ASCL I HC PRO

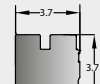
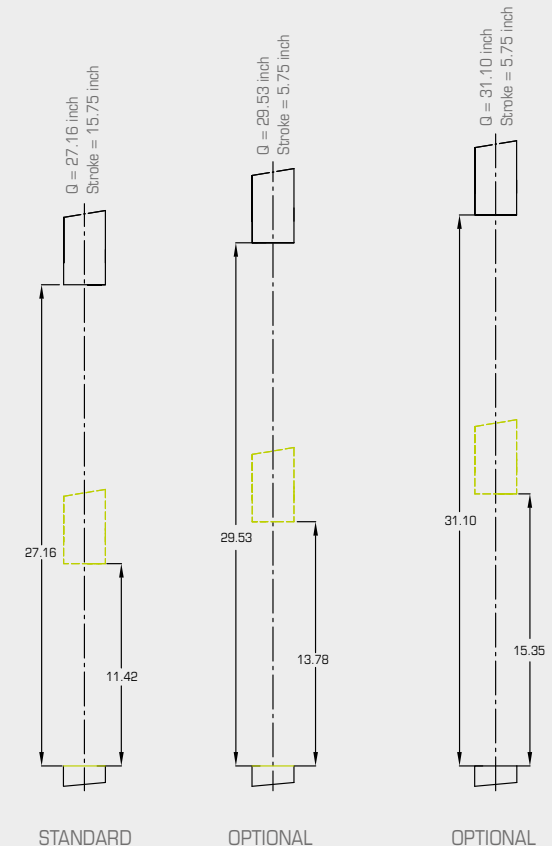

NSCR II MC  
Premium

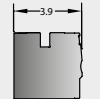

NSCR II HC  
Premium

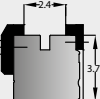

NSCR I PC 2.4in  
Euro Style 2.4in

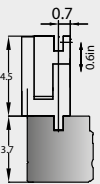

DDD05 MC +  
NSCR I MC PRO



# Technical specifications SafanDarley E-Brake 300T Ultra Dual Drive

E-Brake 300T Ultra Dual Drive	Pressure force in US ton.	Working length in inch	Maximum stroke in inch	Q size in inch	Closing speed in inch/min.	Bending speed max. in inch/min.	Return speed in inch/min.	Motor Power in kW	Weight in Lbs.	A in inch	B in inch	C in inch	D in inch
<b>300-4100</b>	330	160	15.74	27.17	212	48*	212	30	48.500	160,6	211.8	125	134.6

\* Q - dim: Optional: 29.53 or 31.10 inch  
 \*\* CE version: Max. bending speed 24 inch/min.

(Subjects to modifications)

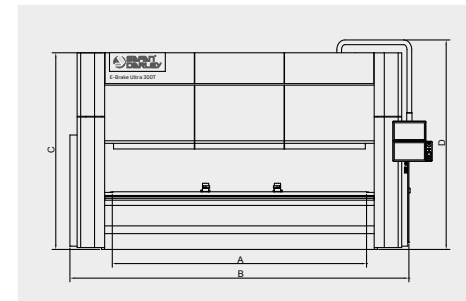
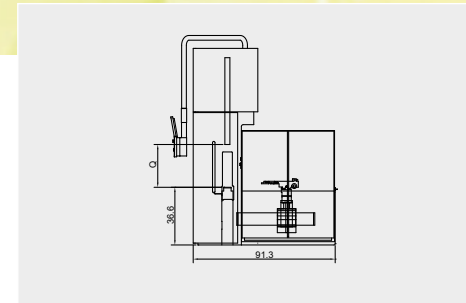
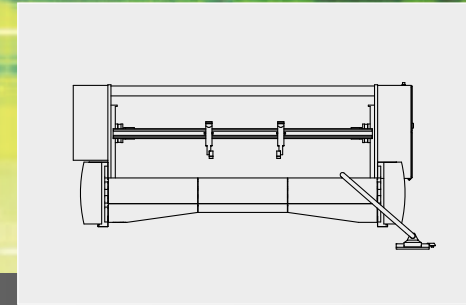

## Accessories (optional)

- CNC-controlled Z1-Z2 axis (horizontal repositioning back gauge fingers)
- CNC-controlled Delta X-axis (horizontal repositioning of one backgauge finger)
- CNC-controlled 3D backgauge (X1-X2-R1-R2-Z1-Z2)
- Built in size of 29.53 inch or 31.10 inch (Q-dimension)
- Various upper and lower tool adaptors
- Various bending aids
- SafanDarley E-Bend S sheet thickness measurement system
- SafanDarley E-Bend L Blue angle measurement system
- Various support arms, fixed, moveable and adjustable in height where required
- Extra Hold To Run operating console for stage bending
- Integrated tool cabinet
- Machine lighting
- SafanDarley E-Control press brake control:
  - EC30 control, complete 2D and 3D graphic programming



E-Brake 35T-40T  
Premium Ergonomic



E-Brake 35T-130T Premium



E-Brake 160T-200T Ultra



E-Brake 50T-130T Ultra



E-Brake 300T Ultra Dual Drive



E-Brake 35T Mini Cell



E-Brake 160T-200T ITC



H-Brake Hybrid 110T-1600



H-Brake Hybrid 110T-170T  
Premium



H-Brake Hybrid 110T-170T  
Ultra



H-Brake 175T-400T  
Ultra



H-Brake HD 500T-1250T  
Ultra



R-Brake 130T



B-Shear & M-Shear



Special cutting lines



SafanDarley B.V., Kwinkweerd 11, NL-7241 CW Lochem  
P.O. Box 96, NL-7240 AB Lochem, The Netherlands  
Tel.: +31 (0)573 222 222, Fax: +31 (0)573 222 299

E-mail: [info@safandarley.com](mailto:info@safandarley.com), Website: [www.safandarley.com](http://www.safandarley.com)



Watch our corporate  
movie here: